

Read  
this first.

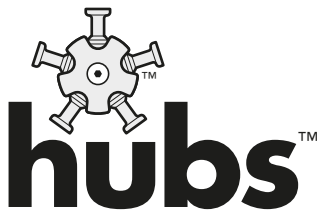

# Big thanks!

Thank you so much for buying a kit.

We hope it will be a start-point for your ideas and enable you to make your dome-based something!

Please read the instructions through carefully so you fully understand how the kit works, and pay particular attention to the next few pages which cover the main things to be aware of before you begin.

Happy dome building!



Chris and Mike

# Principles

These are useful things to remember to help the build go smoothly.

**1**

It takes two



One can connect as the other lifts.

**2**

Stay on the outside during the build

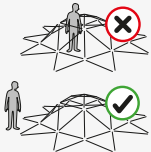

Insert and remove ball connectors in this alignment.

**3**

Insert from below

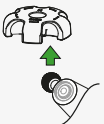

Insert and remove ball connectors in this alignment.

**4**

Lift the hub above to enable connection



Won't connect

**5**

Lift by the sticks above the hub

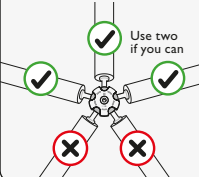

Use two if you can

**6**

Only clamp-up hubs when the dome is in its final position



On its base

Moving the dome whilst clamped-up will damage the hubs and ball connectors!

# Watchouts!

Building your dome should be great fun and the last thing we want is for people to hurt themselves. Here are a few things to watch out for:

**1**

Hubs are hinges



Hold sticks away from the hubs

**2**

Sockets can pinch

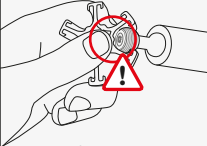

Keep fingertips away from sockets

**3**

Falling sticks

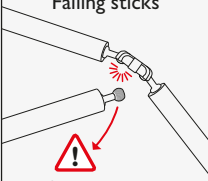

Stay on the outside as you build

**Tip:**  
Wearing gloves minimises the risk.

**Tip:**  
If a stick pops-out just pop it back in!

**X**

Not a climbing frame



**X**

Don't suspend heavy objects



The benefits that hubs bring to the build and adaptation of domes comes at the cost of ultimate strength.

Domes built with hubs are still satisfyingly sturdy structures which are more than strong enough for their intended uses; eg fruit cages, garden rooms, chicken runs etc.

# Before you begin

We believe in common sense and personal responsibility not lots and lots of legal disclaimers, we hope you do too. Despite that, here are a few points we need to make you aware of before you start building.



- Anyone building a dome, dome adaptation or any other structure with hubs does so at their own risk.

**Why say this?**

We only supply the contents of the kit; we're not making the final completed product, **you are**, which is great, but we don't know exactly what you'll make. We hope you'll be sensible and take care as you build your dome.

- Domes built with hubs are not climbing frames and not intended for suspending heavy weights (eg a person in a hammock).

**Why?**

Hubs' flexibility of angles enables a simple build method but comes at the cost of ultimate strength. At a certain weight (a certain force) the ball connectors will pop-out; climbing on or hanging from a dome built with hubs will easily be enough to cause this!

- Domes built with hubs are not designed for use in public spaces, any dome built for public use is entirely the builder and/or event's responsibility. We don't recommend it.

**Why?**

In a crowd, many people could lean on the dome at once, sticks could break or ball connectors could pop out, leading to injury.

**Note:** We're working on it and in the future, may be able to cater for this.

- It is the builder's responsibility to make their own judgement regarding their dome and wind and snow loading.

**Why?**

Occasionally winds can gust to very high speeds and can exert large forces on the frame (especially with a cover, but also as a simple open frame). Similarly, occasionally, heavy snow can build up. Please be aware of this.

- Any covering added to the dome is the responsibility of the builder; please ensure you understand any dangers associated with your cover type (eg ventilation and extreme temperature).

**Why?**

We can't control what kind of cover you may apply to the dome, but please have a think about any potential risks – we don't want you falling asleep in your new moon base and succumbing to heat stroke!



### Hubs and children

The kit isn't a toy but could be good, supervised educational or family project.

You know your kids best, so familiarise yourself with hubs and decide if it's appropriate for them or not.

Please contact us if you are unsure of anything.

# 2v kit overview

## 1. To build the dome

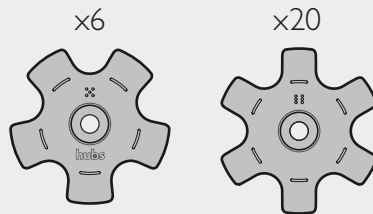

**For the sticks**

The wood screws attach the ball connectors onto the ends of your sticks. See page 11 for more.

x130



Ball connector

x130



Wood screw



Build instructions

x20



Ball connector

x20

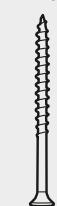

Wood screw

**Tools**

In addition to the kit you'll need a cross-head screwdriver to attach the ball connectors to your sticks and a saw to cut your sticks to the right lengths.

**For the base**

You will need another 10 wood screws or another 20 ball connectors and 20 wood screws depending on which base approach you go for. These are included in the kit. See page 13 for more.

## 2. To clamp-up the hubs



**Locking plate**  
Clamps the ball connectors in place once the dome is in its final position.



**Hub screw**  
Goes through the centre of the hub for clamping.



**Wing nut**  
Screws onto the end of the hub screw to clamp the locking plate in place.



**Hanging eyelet**  
Use this to hang something nice from the centre of your dome.



**Allen key**  
Used to hold the hub screws in position when clamping the hubs.

# Size and sticks.

## Just add sticks

So you've got the kit, now you just need to make your sticks! You only need two lengths. Here's how many you need and a few ideas for woods to use.

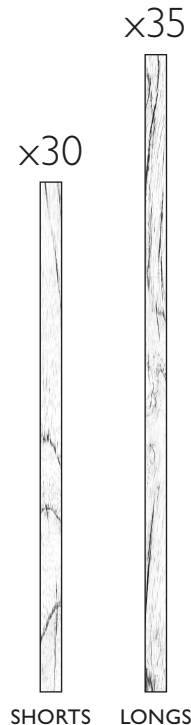

### Ideas for sticks

- Roofing batten
- Hardwood dowels
- Chestnut fence pales
- Oiled oak
- Broom handles & curtain rails?
- Old branches?

### Where to get them

- Local DIY centres
- Garden centres
- Carpenters or wood workers
- Traditional fence makers

### Weather protection

If your dome is going to be outside, protect your sticks with an appropriate oil, varnish or paint. It's easiest to do this before screwing on the ball connectors. Hard woods like oak and chestnut can be oiled or left untreated for a natural look.

?

### Other materials

Bamboo, plastic, metal and other tubes can be used by filling the ends with resin, rubber or wood so that the ball connectors can be screwed on.

*We'd love to hear how you get on if you have a go!*

# Dome size

By making sticks of different lengths you can create domes of different diameters.

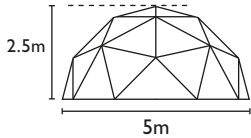
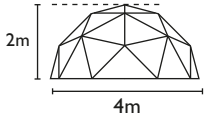
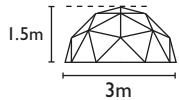

The height in the middle is always half the diameter.



### Space to build

You'll need a bit more space than the diameter of your dome to build it.

### Example sizes

DIAMETER	SHORT	LONG
2m	458mm	530mm
3m	731mm	839mm
4m	1005mm	1148mm
5m	1278mm	1457mm

For other sizes use our online calculator:  
[buildwithhubs.co.uk/sticks](http://buildwithhubs.co.uk/sticks)

### Practical limits

We recommend 5m as a practical size limit, however, the limiting factor is really weight. See opposite page. When domes get too heavy the sticks will start popping out of the hubs during building.

### Going larger

Light sticks or even an alternative material like plastic tubes will help if you want to go larger. Alternatively you could support the dome a bit more as you build.

We've successfully built a 6m diameter dome with light 19mm x 32mm roofing batten without any trouble.

# Stick weight

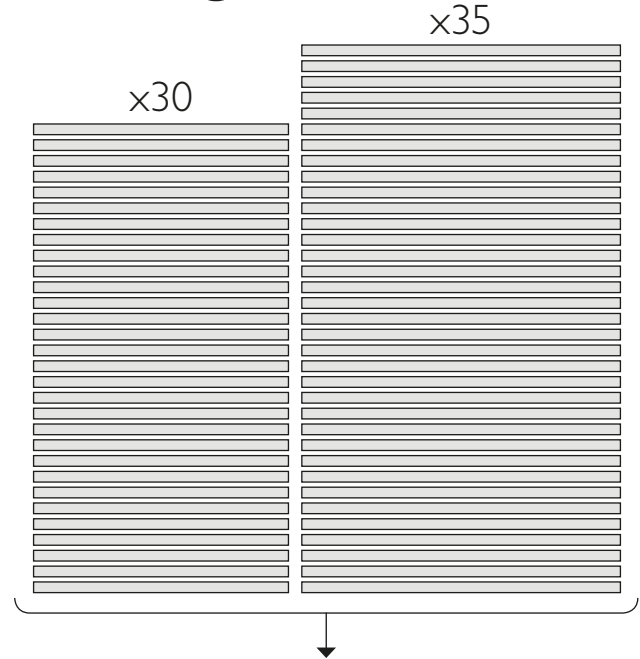

Keep the total stick weight to ~30kg or less

Keep the individual stick weight below 500g (~1 pound).

500g/stick adds up to over 30kg which is getting close to a maximum comfortable weight to work with.

We don't recommend going heavier as the dome will be harder to manage physically and it will also increase the likelihood of pop-outs during building.

# Preparing your sticks

## Recommended

up to 32mm

(1¼" APPROX)

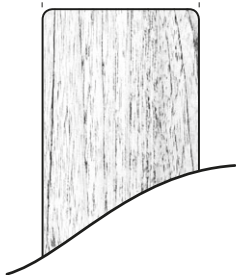

## Tapering required

above 32mm

(1¼" APPROX)

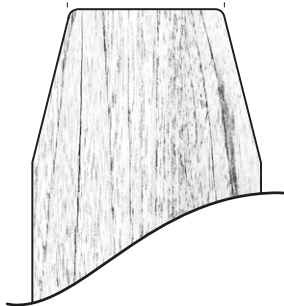

### Stick width

We'd recommend keeping your sticks below 32mm in width to keep them at a good weight for construction. If you go wider you will need to taper to avoid the ends of the sticks clashing at the hub during the build.

### Cutting your sticks

Try to keep the ends as square as you can. Hubs allow for a little bit of inaccuracy, so don't sweat it trying to get every stick perfectly square and to the exact millimetre.

cut square

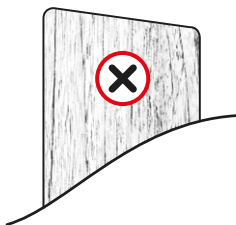
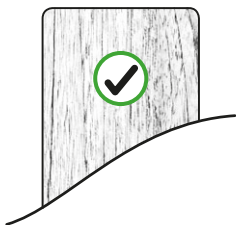

# Attaching ball connectors

We find it works best if you put the wood screws into the ball connectors before positioning them on the ends of your sticks. Binding sticks together into bundles also helps to speed things up.

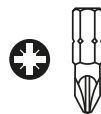

A Pozidriv (PZ2) is the most common cross-head bit.



Hold the ball connector flat on the end of the stick to help guide the screw in straight.



### Soft and green woods

You can screw straight in.

### Hard woods

Drill a 2-3mm diameter pilot hole to a depth of 35mm to avoid splitting.



#### Powertools

Don't use too high a torque setting if you're using a power tool as you could strip the wood or damage the ball connectors. They're pretty durable but go easy on your first one to get a feel for it.

# Base options.

## Hub orientation

There are two ways of connecting the bottom ring of hubs to your base.

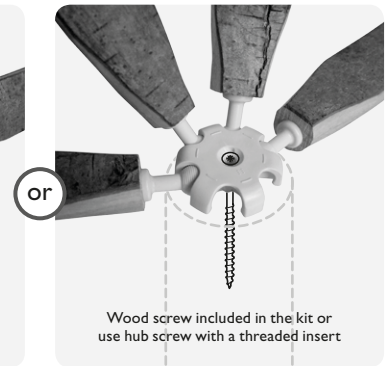
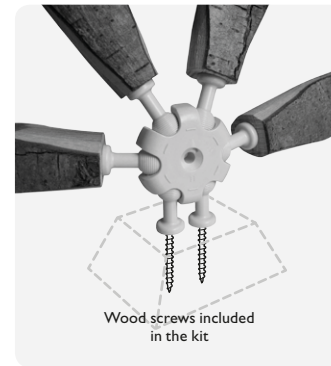

### 1. Standing up

Screw two ball connectors 3mm apart onto your base. You could also use two ball connectors in a hub as a template. Test your first attempt in a hub to check that the position is ok.

Tip:

If proving tricky, slightly loosening one ball connector helps.

### 2. Lying down

The hub sits horizontally and a screw through the centre of the hub can fix it to the base. It's also possible to use a hub screw if you embed an M6 threaded insert in your base.

?

#### Temporary use

It is possible to simply rest your dome on the ground using the lying down approach. Stake through the centre of hubs or stake down the bottom ring of sticks. If the dome is on a hard surface use metal weights or sandbags to secure the base in position.



# Base types

There are all sorts of ways you could create a base for your dome. Here are a couple of simple suggestions. You can use either of the hub orientations shown on the previous page.

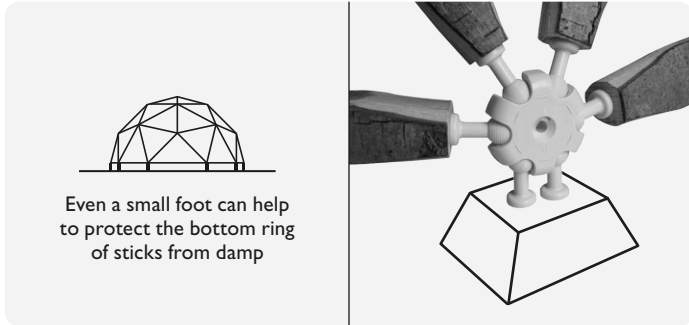

Even a small foot can help to protect the bottom ring of sticks from damp

## 1. Small feet

These can simply be blocks of wood. Drill with holes so you can stake them to the ground. You can also add eyelets or hooks for attaching covers.



### Anchor your dome

Whichever base approach you use ensure that the dome and any cover is securely anchored to the ground. Wind can place an enormous force on sheet covers and even netting.

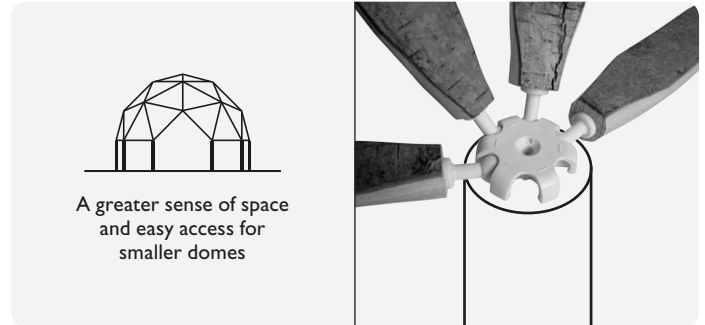

A greater sense of space and easy access for smaller domes

## 2. Posts

Build your dome first and mark the position of the hubs. Then make holes with a little wiggle room so you can adjust the position of posts when you put the dome on top. Once the dome is mounted, fill the holes around the posts.



### Not too wide

If the hub is lying down make sure the width of the feet or posts is 70mm (2¾") or less to be sure that they don't clash with the sticks.



Get the angles in the base ring as consistent as you can before fixing in place.

# Building your dome.

## How to build your dome.



Version 1  
Waterproof and tearproof

The separate build instructions include other useful information to have to hand during the build:

- Principles and Watchouts!
- Parts checklist
- Guidance on base approaches
- Checking hub alignment
- Clamping-up hubs
- Taking down your dome

*It's also waterproof and tearproof so will survive outside.*

*Once you've got the ball connectors on your sticks you'll have your dome up in no time!*

Open it up to reveal the build instructions:

## The build

Read out the descriptions and check progress against the illustrations.

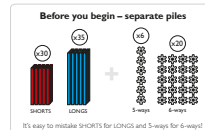

Step	You need	Description (read this out to someone helping you)	It should look like this!
1	1 SHORTS hub (A5) and 1 SHORTS (A5)	<ul style="list-style-type: none"> <li>Start with a 5-way hub in the middle and connect SHORTS into it.</li> <li>Hubs should always face up and sticks always connect in from below.</li> </ul>	
2	1 SHORTS hub (A5) and 1 LONGS (A5)	<ul style="list-style-type: none"> <li>Snip a LONGS hub onto the end of each SHORTS.</li> <li>Place LONGS around the outside and connect them into the 6-way hubs.</li> <li>Use the centre 5-way hub by its sticks to make the final connection.</li> </ul>	
3	1 SHORTS hub (A5) and 1 LONGS (A5)	<ul style="list-style-type: none"> <li>Connect a pair of LONGS into the left and right free sockets of the 6-way hubs (keep the middle socket free).</li> <li>Use 6-way hubs to connect the LONGS together to create triangles.</li> </ul>	
4	1 SHORTS hub (A5) and 1 LONGS (A5)	<ul style="list-style-type: none"> <li>Connect a SHORTS into the remaining free socket of each 6-way hub.</li> <li>Snip a SHORTS hub onto the end of each SHORTS.</li> </ul>	
5	1 SHORTS hub (A5)	<ul style="list-style-type: none"> <li>Place SHORTS in a ring around the structure so far.</li> <li>Work your way around the ring, connecting the sticks one at a time – when you can't make a connection use the hub above.</li> </ul>	
6	1 SHORTS hub (A5) and 1 LONGS (A5)	<ul style="list-style-type: none"> <li>Connect SHORTS into the 5-way hubs and LONGS into each of the 6-way hubs.</li> </ul>	
7	1 SHORTS hub (A5)	<ul style="list-style-type: none"> <li>Use SHORTS 6-way hubs to connect SHORTS and LONGS together into triangles.</li> <li>Use sockets that are next to each other on the hubs.</li> </ul>	
8	1 SHORTS hub (A5)	<ul style="list-style-type: none"> <li>Place LONGS in a ring around the outside.</li> <li>Work your way around the ring, connecting the sticks one at a time – use sockets either side of those already populated – when you can't make a connection use the hub above.</li> </ul>	

**DOME DONE!**  
Check out the  
Completing your dome  
section for next steps.



geodesic domes  
made simple

# Correcting alignment

After a build some hubs may not be in the correct alignment. Check each hub and correct as necessary.

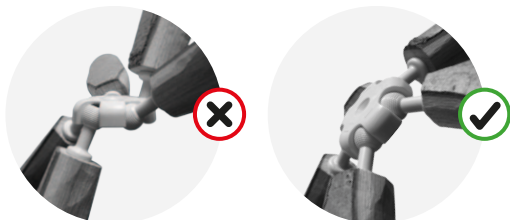

Correct by pulling sticks towards the outside of the dome.

Pushing inwards can pop sticks out of the hubs!

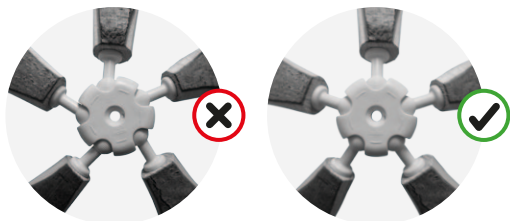

Tap sticks left and right to correct rotational misalignment.

*Hubs have a preference for the right position, see if you can feel them snap into place as you correct their alignment.*

# Clamping-up hubs

Only clamp-up the hubs once the dome is in its final position. Once finger-tight use the allen key to clamp firmly.

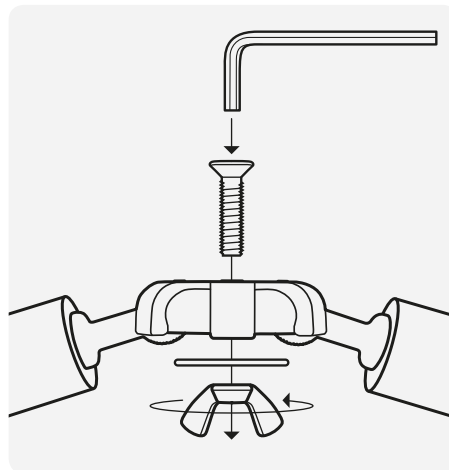

## Moving your dome

Before the hubs are clamped-up you can move your dome to a new position. Two people should be able to drag it and we recommend four or more people if you're going to lift the dome.



## Un-clamp all hubs before moving a dome

Moving a dome whilst the hubs are clamped-up will damage the hubs and ball connectors!

# Thoughts on covers.

## Plan overview

The dome is made up of 40 triangles; 30 with two SHORTS and a LONG as the sides. And ten equilateral triangles with three LONGS for sides.



You can view it as six pentagons with ten equilateral triangles filling in the gaps:

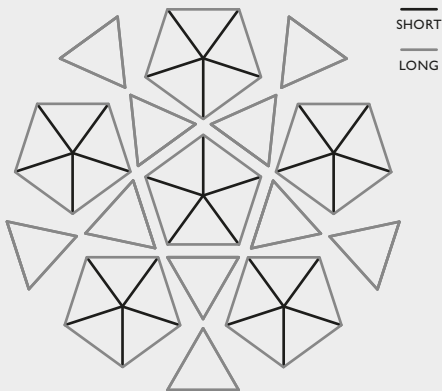

*There's quite a bit to figure out so it might be best to build your dome and then measure and test to figure out your cover approach.*



### Lengths for covers

Our calculator automatically takes off 88mm to account for the space that the hubs take up. Add the 88mm back on to both SHORTS and LONGS to get the point-to-point dimensions for the triangles when working out your cover.

## A few ideas

In time we hope to have some useful guides on our website. Here are a few ideas to start with in the meantime and there are also lots of resources online if you search around a bit.

### Cover approaches

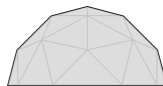

#### Full

Completely enclose the space.



#### Partial

A mixture of shade and light.

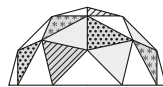

#### Triangles

Mix materials and colours and cover some or all of the dome.

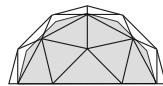

#### Hanging inside

The dome becomes an exoskeleton — our favourite!

### On the outside or inside?

If your cover is on the outside it hides the structure, although it can be nice to see it from the inside.

If you hang it on the inside you can still see the structure from the outside but you'll need to reduce dimensions to take account of the smaller size.

### Material ideas

- Yachting canvas
- Stretchy fruit cage netting
- Camouflage netting
- Heatshrink plastic
- Ripstop nylon
- Reflective tent fabrics
- Insulation boards

### Other ideas

- Grow plants over your dome
- Cover it in fairy lights
- Hang lanterns from hubs



### Risks

Please attach and anchor your cover securely. Please also ensure that you investigate and understand any risks associated with your cover type; eg ventilation and very high temperatures in a greenhouse.

# Adapting your dome.

## A few ideas

With hubs the angles aren't fixed which means you can adapt! You could try an igloo entrance, adding a side-shelter or maybe even combining two or more domes?

### Adaptation ideas

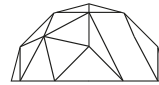

#### Simple door

A large entrance for easy access.

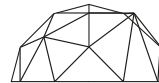

#### Raised triangle door

Lengthen bottom four sticks.

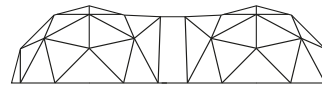

#### Connected domes?

Two spaces for two uses?



**Altering the basic structure will affect the structural integrity of your dome.**

Test your adaptations to ensure they don't make the structure weak or at risk of collapsing. Secure the base firmly to get a true sense of whether an adaptation is structurally sound.

### Adaptation technique

Here's a great way to try new ideas. Do this for each stick you want to adjust.

#### Step 1

Cut two lengths of cheap batten, that combined will be greater than the length of your new stick. Attach a ball connector to one end of both battens.



#### Step 2

- Remove a stick from your dome and connect one of your 'Adaptor' sticks into the first hub and the other into the second hub.
- Alter the overlap until they are at the desired length and screw together in two places to fix.

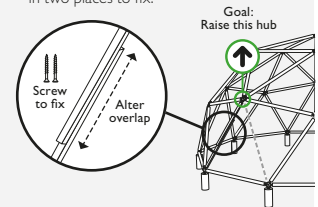

#### Step 3

If you're happy with the length measure the stick to create your final stick in your preferred material.

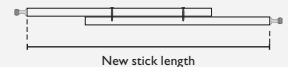

# Dome done!

We'd love to see what you create, send us a picture.  
Hopefully in time we'll have a gallery on our website.

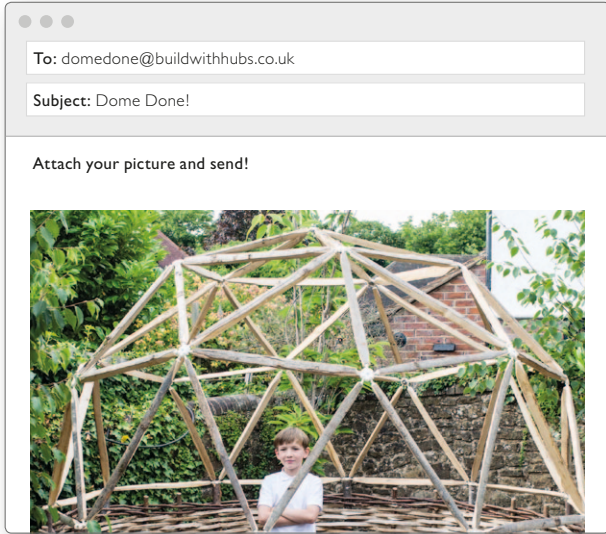

Any other questions, email us here:  
[help@buildwithhubs.co.uk](mailto:help@buildwithhubs.co.uk)

© Build With Hubs Ltd. All rights reserved.  
The 'hub icon' and 'hub icon' together with  
the 'hubs' wordmark are trademarks of  
Build With Hubs Ltd.

[buildwithhubs.co.uk](http://buildwithhubs.co.uk)

*Big thanks to all our Kickstarter backers who made this possible!*

Ben Rubinstein, Truninger, Dave Rotheroe, Nor Calm, Stephanie A. Chuah, Earendil Engelman, Davis Beeman, Fiona Cheng, Jonathan Anders, Tiny Hamster, Andrew Condon, Jonathan43551, Cliff, Louis-Philippe Loncke, kokobin, Louie Amplett, Keirsten Gustafson, Johannes Fuchs, Jeroen den Ridder, Susan Haseltine, Luigi Cicala, Bobby Iliev, Tom Bamford, 3rd Dimension Gear (3DG), Joel Parker Henderson, Dick Van Den Berg, ShimmerGeek, Kate Bolin, Pedro Mendonça, Ste Allan, Andy Mills, Rainer Neumann, Will Reed, Jason Galyon, Joana Seguro, Bobby Martin, Stefan Schwab, Istvan and Michael, Gary Gowans, Jim Sloan, Graeme Haig, Zack Peters, Leigh Warner, Patrick Prosser, Bruce Long, Jonathan Östberg, Israel Caballero, Thomas McFarland, Pete Anderson, Rosemarie Vos, Rachel, Ryan Hemphill, Steven Fett, Stephen "Hiroshi" Wykes, Dave Joubert, Mark Streett, Miguel Martinez De Salinas, Alexander von Schlinke, Mark Gronnow, Pat Connelly, Carlos Izsak, Rich Ryan, Joaquim Afonso da Cunha, Roger Beckett, Simon Anderson, Remiaf7, Matthew Paisley, Christine Flanagan, David Winterbottom, László Zsuzsanna, Tom Avison, Jan Vegt, Niall McCormack, Lee R. Copp, Dominic Tostell, Emilie Calhaem, Steve Chilton, Inaki elizondo, Claire Golding, Paul Clarke, Antonio Nascimento, Brian Smith, Gayle Snible, Jo Bellingham, corhub, velioze, Russell Davies, Magnus Wittström, Marc, Simon S. Allen, Martin Jefs, Robin, Emily Dourish, Rose C, Elaine McCudgill, Dan Julian, Diana, Ben Donaldson, Frauke Westgate, Patient 0, Tracy Richmond, Leah Tardivel, Jim Thompson, Jakob Edens, Clairre Yochana Sommer, Tim Hopkin, Laura Butchins, Rob Carter, Alice Taylor, Bruce Mcmurdo, Benjamin Drew, Will Verrier, Tom Jewell, Jon Potts, Darius Zaerin, Darryn Bruton, Ben Randall, Julian G Hicks, Tom Berge, Mike Inglis, Richard Loader, Lizzy Townshend, Mark Lorch, Daniel Winterhalter, Dávis Freimanis, Tom Sperling, Craig Moehl, Shane, Timothy Dean, John-Paul Bland, Nicholas Giacomelli, Thomas Schäfer, Egor Osutin, Rakesh Patel, Steve, Brendan O'Brien, Derek Perez, William Bettridge-Radford, Alaa Alghufali, Christopher Seaton, Hans Biebuyck, Ritschat, Art Beseman, Adam Baker, Evan Willemsen, Phil Drew, Leo Frollini, Stephen Charles Taylor, Matthew Bednar, Pascal roulin, Rooney M, Petr Hejkal, Armin Seltz, Maxwell, Paul Richmond, Sean Campbell, Dave Elvis Elder, Mark Keating, Nigel Payne, Sheldon Radcliff, Matthew, Ren Campbell, David P. Taylor, Mark Howard, Hannah Clinch, Alexander Scholten, Stefan Schlumbom, Derf Lewis, Jenny Pickles, Ellie Hartley, Stuart Lawn, Tim Barnes, David Brickwood, Antoine Hertenberger, Marcus, Gaspard de Jong, Russell Rogers, Ulf Preisler, Adrian, Rupert Mills, Anders Morgenthaler, Jan, Tom Pollard, Mike Grenville, J Wes Goswick, Maggie Young, Teresa Wgagner, Rob Lang, Gordon Fletcher, Abbie Read, Jann Krynauw, Dwight Bishop, Jack Renwick, John, Stephen Holden, Benjamin BRENNEUR, Josh Sheldon, Patrick Hegen, Ronald The, Bik Khuu, Charlie Knight, Paul Scott-Wilson, B, Tuebor, Rick Mason, Rob Meekings, Andie Nordgren, Lars, Mat Hampson, Jeremy Wright, Dom Bailey, Honorine Parrish, Carlos AJunco, Bobby Young, Tom Martin, Matthew harker, Bryan Lipscombe, Daan Debuysere, Bob Bechtold, John Brennan, Nicolas Guibert, Marcus Custodio, Andrea Jones, Bergho, Jai Bishop, VERTICALGREEN, Jonathan Pui, Hans Juergen Pollitt, Tönn London, Philippe Morel, Max Dusseldorf, James Accurso, Dave, Christopher Daniel, Judith DeSmet, Elias Thoma, Robert Veselko, Brad Chittock, Nicolette Van Kooten, Hubert Gertis, José Luis Pereira, Hans Wurst, Herman Veluwenkamp, Thomas Sowell, Sarah, Kirill, David Zhang, Larry Cuba, JollyOrc, Steve Welburn, Gregor Brunner, Mary Ashley Morales, Stella Kutz, Caitlin Rosen, Dmytro Poberezhny, Carsten von Massow, Mark Thompson, René Kragh Pedersen, RahimaSage Teall, John David McKinley, Halina Kaja Mydin, Nick Parfitt, Bill H, Stanley Dobrowski, George Strakhov, Ray Walsh, John Hogan, Charles Cleo, Lexi Henshel, Andy Woodman, Sari Griffiths, Anthony Rowe, Xavier Bernasconi, Daniel Pereira, Adam S. Hyde, Jonatha, Chris, Dominic Bowen, jonathan kean, Kathryn E. Bechtold, Alan Greene, Jacobo Zaga R., Brian Wolter, Andy Thorne, Ryan Sullivan, Mark Nichols, Woody Grimsby, Ken Pisarczyk, Oliver Pinchbeck, Phillip Martinez, Helen Jones, Steve Madley, BVAC Ventures, J P Diver, krenzke, Lesley VERBRUGGE, Henning Kramer, Heather M Clayton, Lisa Coleman, Michael Chrobok, Marcio Haddad, Kim, Stéphane Magnin, Miriam Richards, LaMaisonDémontable, Robert, Jayme Oates, Christina, Jaile, bonninea, Edward Muller, Mike Paunovich, Jackson K W Tang, Lucy Lenton, grigo77, Enda Phelps, Jacob Lindgren, Jeff Falk, Kristof Claes, J Pregerson, Derek Simpson, Seonmyoung Kim, Fans, RK Farley, Alex David, Valentine\_13, Joshua Kooiman, Maarten, Martin P., Erik, Geir Hauksson, Nicole Reineker, Robert de Graaff, BRASSART BRIGITTE, Dominic Kelly, Cameron Leeson, Pieterjan Heyse, James Jackson, Kevin Lynch, Phil McCaffry, Fiona Duncan, Phil Hooker, Michael, Sir Richard Meyer – Knight of Valoria, B de Winkell, JohnFera, Philipp Schneider, Oliver Schapp, Vball coach, Amir Revivo, Gareth Niblett, Dusan Sempel, J Livingston, Jane Baker, Markus Meichau, Marc, Stephen Gardner, Robert Mastin, Daniel, Mieke VdB, Christof Recknagel, Michael Kueberth, Rune Dyrholm, Tom Sarsons, Jon Lyksett, MrChristopher, Ruth wheeler, David Norris, Morten Smith, maylin, arno langeV1, Sam Donald, Brendan Watson, Jonhan Foucaut, ocebnaire, Andrew Hedges, Matt, David Gillard, Dave Woodruff, Sam Paisley, Barry, Mat & Mary, Roy Hill, F.T., Colin Packham, Louise Cartledge, gab5, Thomas Horrobin, Chris Crabtree, John Lee, Keith Hancox, Jonathan Rowley, John Dimatos, Faisal Binladen, John Dyer, Marcus. And special thanks to Helen, Jo and our parents and family for their support and understanding (and money!).

Geodesic  
domes  
made  
simple.

